

■ Metal Alloy Low Resistance Chip Resistor — MAL Series

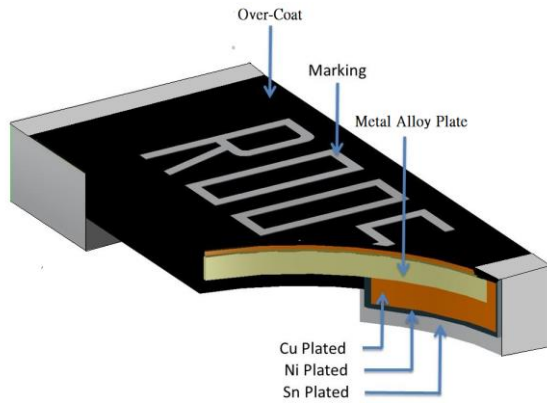

■ Application

- Entertainment product
- Power supply
- Measuring instrument
- Industrial product
- Battery management system

■ Features

- Low Resistance / Low TCR/Low Inductance($\leq 5\text{nH}$)
- Excellent long term stability
- RoHs compliant and halogen free.
- Lead free.
- High precision current sensing and voltage division.
- AEC-Q200 qualified available.

■ Parts Number Explanation

■ Example:

MAL	2512	20	F	R001	M	Z
Product Type	Size (Inch)	Rated Power	Tolerance	Resistance	Material	Optional
Low-Inductance Metal Alloy Low Resistance Resistor	1206 2512 4527	10=1.00W 15=1.50W 20=2.00W 30=3.00W 50=5.00W	F : $\pm 1\%$ J : $\pm 5\%$	0m50=0.5mR 2m50=2.5mR R005=5.0mR R250=250mR	S : MnCuSn M : MnCu R : NiCrAl	Z : Default code



MAL Series Metal Alloy Low-Resistance Resistor Product Specifications

Document No.	S-10-12-32-10
Released Date	2022/12/02
Page No.	2/8

Standard Electrical Specifications

TYPE	Rating Power at 70°C	T.C.R. (ppm/°C)	Max. Rating Current	Max. Overload Current	Resistance Range (mΩ)		Material	Operating Temperature Range (°C)
					0.5% (D)	1.0% (F) 2.0% (G) 5.0% (J)		
MAL1206	1W	$\leq \pm 50$	31.62	63.24	7~10	1~10	R001 : MnCuSn R002~R010: MnCu	- 55 ~ + 170
MAL2512	1W	$\leq \pm 75$	54.77	109.54	-	0.5~0.75	R0005~R00075 : MnCuSn R001~R015 : MnCu R016~R250 : NiCrAl	
	1.5W	$\leq \pm 50$	38.72	77.45	7~250	1~250		
	2W	$\leq \pm 75$	63.24	126.49	-	0.5~0.75		
		$\leq \pm 50$	44.72	89.44	7~120	1~120		
	3W	$\leq \pm 75$	77.45	154.91	-	0.5~0.75		
		$\leq \pm 50$	54.77	109.54	7~20	1~20		
MAL4527	2W	$\leq \pm 75$	63.24	141.42	-	0.5	R0005 : MnCuSn R001~R040 : MnCu	
		$\leq \pm 50$	44.72	100.0	7~40	1~40		
	3W	$\leq \pm 75$	77.45	173.20	-	0.5		
		$\leq \pm 50$	54.77	122.47	7~40	1~40		
	5W	$\leq \pm 75$	100.00	200.00	-	0.5		
		$\leq \pm 50$	70.71	141.42	7~40	1~40		

Type Dimension

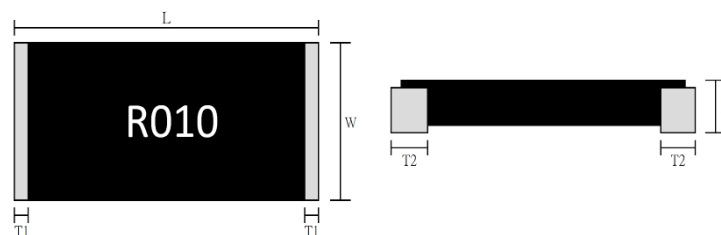



MAL Series Metal Alloy Low-Resistance Resistor Product Specifications

Document No. S-10-12-32-10

Released Date 2022/12/02

Page No. 3/8

Dimension

Unit : mm

Type	Power Rating	Resistance Range	L	W	H	T1	T2					
MAL1206	1W	1mΩ	3.200±0.254	1.650±0.254	0.770±0.254	0.508±0.254	0.508±0.254					
		2 mΩ			0.650±0.254							
		3~10 mΩ			0.550±0.254							
MAL2512	1W	121~200 mΩ	6.350±0.254	3.050±0.254	0.400±0.254	0.75±0.254	1.100±0.254					
	1.5W	201~250 mΩ			0.820±0.254		1.980±0.254	2.000±0.254				
	1W	0.5mΩ			0.5mΩ	0.700±0.254	1.150±0.254	1.980±0.254	1.980±0.254			
					0.75mΩ	0.720±0.254				2.000±0.254		
					1mΩ	0.720±0.254				1.400±0.254		
					1.5mΩ	0.720±0.254				1.150±0.254		
					1.5W	2~5mΩ				0.550±0.254	1.100±0.254	
					2W	6 mΩ				0.500±0.254	1.100±0.254	
	3W	7~15 mΩ			7~15 mΩ	0.400±0.254	1.150±0.254	1.980±0.254	1.980±0.254			
					16~100 mΩ	0.720±0.254				2.000±0.254		
					101~120 mΩ	0.720±0.254				1.400±0.254		
					0.5mΩ	0.720±0.254				1.150±0.254		
					0.75mΩ	0.550±0.254				1.100±0.254		
					1mΩ	0.500±0.254				1.100±0.254		
	MAL4527	2W			0.5mΩ	11.30±0.50	6.60±0.50	0.770±0.254	0.90±0.254	3.000±0.254		
					1mΩ			0.650±0.254			2.000±0.254	
					3W			1.5~20mΩ		0.550±0.254		0.65±0.254
								21~40 mΩ		0.800±0.254		
5W		0.5mΩ	0.5mΩ	0.680±0.254	0.65±0.254			2.000±0.254				
			1mΩ	0.580±0.254								
			1.5~20mΩ									
			21~40 mΩ									



MAL Series Metal Alloy Low-Resistance Resistor Product Specifications

Document No. S-10-12-32-10

Released Date 2022/12/02

Page No. 4/8

■ Performance Characteristics

Power Derating Curve

The Operating Temperature Range: -55°C ~+170°C.

For resistors operated in ambient temperatures above 70°C, power rating must be derating in accordance with the curve below.

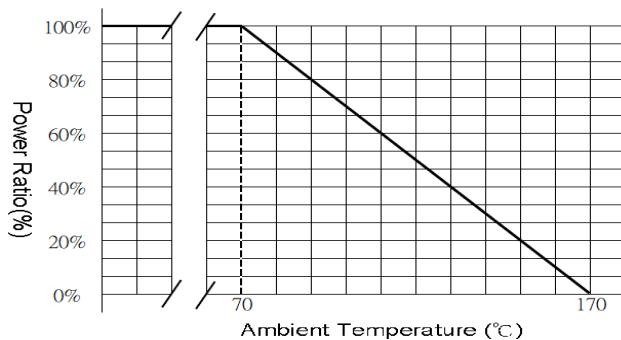

■ Rating Current

The following equation may be used to determine the DC (Direct Current) or AC (Alternating Current) (RMS, root mean square value) of normal rated power. However, if the result value exceeds the highest current of regulated standards (paragraph 5), the highest normal rated power is to be used

$$I = \sqrt{P/R}$$

I = Rating current (A)
P= Rating Power (W)
R= Resistance(Ω)

■ Inductance characteristics: $\leq 5\text{nH}$ (Circuit frequency is below 1MHz)

■ Marking Format:

- All the other products marking are 4 digits.
- “R” designates the decimal location in ohms
e.g. 1mΩ the product marking is R001.
25mΩ the product marking is R025.
100mΩ the product marking is R100.
- “m” designates the decimal location in milli-ohms
e.g. 5.5mΩ the product marking is 5m50.
25.5mΩ the product marking is 25m5.
- The criteria to distinguishing the mark on the surface of products are that characters can be identified.



MAL Series Metal Alloy Low-Resistance Resistor Product Specifications

Document No. S-10-12-32-10

Released Date 2022/12/02

Page No. 5/8

Reliability test and requirement

Test Item	Test Method	Procedure	Requirements
Temperature Coefficient of Resistance (T.C.R)	JIS-C-5201-1 4.8 IEC-60115-1 4.8	At 25°C /+150°C, 25°C is the reference temperature	As Spec
Short Time Overload	JIS C 5201-1 clause 4.13 IEC-60115-1 4.13	The number of rated power are as follows: <ul style="list-style-type: none"> • MAL 1206-1W: 4 times of rated power • MAL 2512-1.5W: 5 times of rated power • MAL 2512-2W: 5 times of rated power • MAL 2512-3W: 4 times of rated power • MAL 4527-2W: 5 times of rated power • MAL 4527-3W: 5 times of rated power • MAL 4527-5W: 4 times of rated power Rating power duration: 5secs	<ul style="list-style-type: none"> • MAL4527: $\Delta R/R1 \leq \pm 2.0\%$ • Other: $\Delta R/R1 \leq \pm 1.0\%$
High Temperature Exposure	JIS C 5201-1 clause 4.23.2 IEC 60068-2-2	1,000hrs at + 170 °C	<ul style="list-style-type: none"> • MAL4527: $\Delta R/R1 \leq \pm 2.0\%$ • Other: $\Delta R/R1 \leq \pm 1.0\%$
Soldering Heat	JIS C 5201-1 clause 4.18 IEC-60115-1 4.18	260±5°C for 10 seconds.	$\Delta R/R1 \leq \pm 0.5\%$
Temperature Cycling	JESD22 Method JA-104	1000 Cycles (-55°C to +155°C) Measurement at 24±4 hours after test conclusion. 30min maximum dwell time at each temperature extreme	$\Delta R/R1 \leq \pm 0.5\%$
Bias Humidity	MIL-STD-202 Method 103	1,000 hours; 85°C / 85% RH, 10% of operating power. Measurement at 24±4 hours after test conclusion.	$\Delta R/R1 \leq \pm 0.5\%$
Load Life (Endurance)	JIS-C-5201-1 4.25 IEC-60115-1 4.25.1	70±2°C, RCWV or Max. working voltage whichever is less for 1000 hrs with 1.5 hrs "ON" and 0.5 hr "OFF" .	<ul style="list-style-type: none"> • MAL4527 & MAL2512 2W 101~120 mΩ: $\Delta R/R1 \leq \pm 2.0\%$ • Other: $\Delta R/R1 \leq \pm 1.0\%$
Solderability	JIS-C-5201-1 4.17 IEC-60115-1 4.17	245±5°C for 3 seconds.	>95% coverage
Dielectric Withstanding Voltage	JIS-C5201-1 4.7	Applied 500VAC for 1 minute.	No short or burned on the appearance.
Core Body Strength	JIS-C5201-1 4.15	Central part pressurizing force : 5N , 10 seconds	No broken
Terminal Strength (SMD)	AEC Q200-006	Pressurizing force 17.7N for 60 seconds	No broken
Bending Strength	JIS-C-5201-1 4.33 IEC-60115-1 4.33	Bending once 2mm for 10 seconds	$\Delta R/R1 \leq \pm 0.5\%$ No broken
Moisture Resistance	MIL-STD 202 Method 106	T=24 hours / Cycle ,10Cycles . Steps 7a& 7b not required. Unpowered . (Figure 1)	$\Delta R/R1 \leq \pm 0.5\%$



MAL Series Metal Alloy Low-Resistance Resistor Product Specifications

Document No. S-10-12-32-10
 Released Date 2022/12/02
 Page No. 6/8

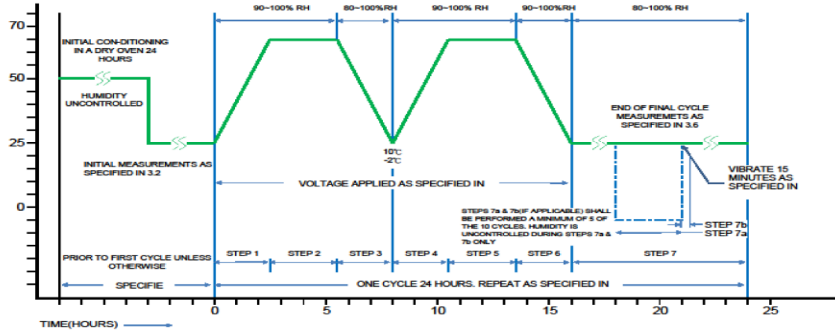
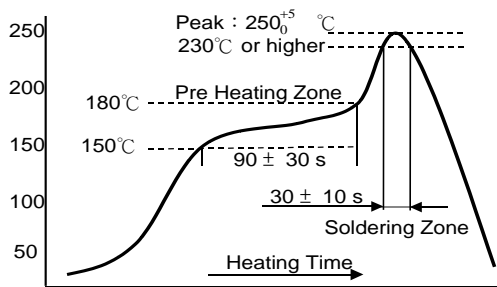
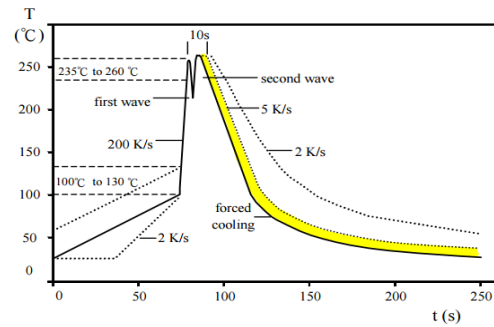

Figure 1

Soldering Profile



Reflow Soldering



WAVE soldering.

Recommend Land Pattern Design

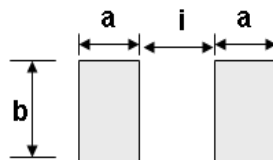

Dimension

Unit: mm

TYPE	Resistance Range	a	b	i
MAL1206-1W	1mΩ~10mΩ	1.46	2.15	1.68
MAL2512 -1,1.5, 2W,3W	0.5mΩ~1mΩ	3.24	3.68	1.27
	1.5 mΩ	3.20	3.68	1.35
	2~5mΩ	2.60	3.68	2.55
	6mΩ~200mΩ	2.30	3.68	3.15
	201mΩ~250mΩ	2.05	3.68	3.65
MAL4527 -2W,3W,5W	0.5mΩ~1mΩ	4.50	8.74	4.50
	1.5mΩ~40mΩ	3.50	8.74	6.50



MAL Series Metal Alloy Low-Resistance Resistor Product Specifications

Document No.	S-10-12-32-10
Released Date	2022/12/02
Page No.	7/8

■ Packing Quantity

TYPE	PCS /Reel	Parts Number Explanation
MAL1206	5000	Z: 5000PCS
MAL1206 R001	4000	Z: 4000PCS
MAL2512	4000	Z: 4000PCS
MAL4527	1000 / 500	Z: 1000PCS 0: 500PCS

■ Plating Thickness:

Ni: $\geq 2\mu\text{m}$

Sn(Tin): $\geq 3\mu\text{m}$

■ Label :



■ Appendix For SMD Chip Resistor

● Packaging Information

■ Reel Dimensions

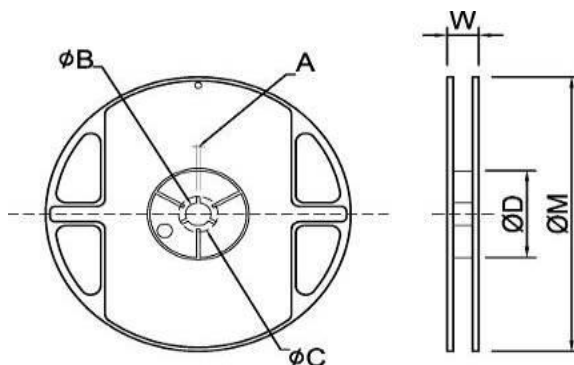

■ Dimension

Unit: mm

Reel Type	A	φ B	φ C	φ D	W	φ M
7" reel for 8 mm embossed (for MA1206)	2.0±0.5	13.2±0.5	17.7±0.5	60.0±0.5	12.0±0.5	178±1.0
7" reel for 12 mm embossed	2.5±0.5	13.5±0.5	17.7±0.5	60.0±0.5	16.2±0.5	178±1.0
7" reel for 24 mm embossed	2.0±0.5	13.2±0.5	17.7±0.5	60.0±0.5	24.4±2.0	178±1.0

■ Embossed Dimensions

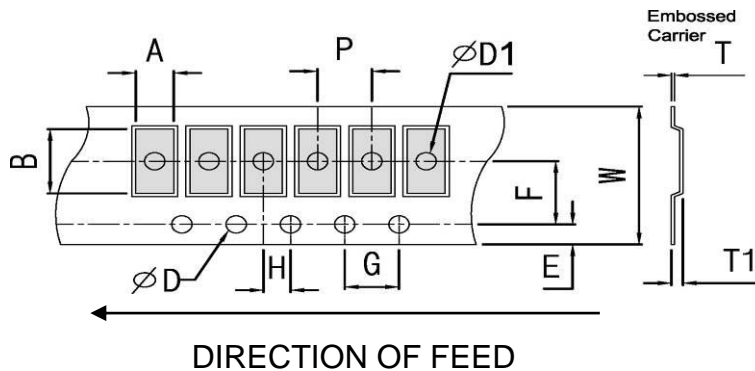

■ Dimension

Unit: mm

Item	Resistance Range (mΩ)	W	P	E	F	φD	φD1	G	H	A	B	T1	T
MAL1206	1mΩ	8.0±0.30	4.0±0.10	1.75±0.10	3.5±0.10	1.50 ^{+0.1} ₀	1.0±0.10	4.0±0.10	2.0±0.10	2.03±0.10	3.55±0.10	1.10±0.10	0.20±0.05
MAL1206	2~10mΩ	8.0±0.30	4.0±0.10	1.75±0.10	3.5±0.10		1.0±0.10	4.0±0.10	2.0±0.10	2.03±0.10	3.55±0.10	0.85±0.10	0.20±0.05
MAL2512	0.5~2mΩ	12.0±0.30	4.0±0.10	1.75±0.10	5.5±0.10		1.55±0.10	4.0±0.10	2.0±0.10	3.50±0.10	6.75±0.10	1.10±0.10	0.20±0.05
MAL2512	2.5~250mΩ	12.0±0.30	4.0±0.10	1.75±0.10	5.5±0.10		1.55±0.10	4.0±0.10	2.0±0.10	3.50±0.10	6.75±0.10	0.90±0.10	0.20±0.05
MAL4527	0.5~40mΩ	24.0±0.30	12.0±0.10	1.75±0.10	11.5±0.10		1.50±0.10	4.0±0.10	2.0±0.10	7.38±0.10	12.0±0.10	1.05±0.10	0.30±0.10

■ Storage Temperature

Temperature : 25±5°C, Humidity : 60±20%