

■ Metal Alloy Low Resistance Chip Resistor — MR Series

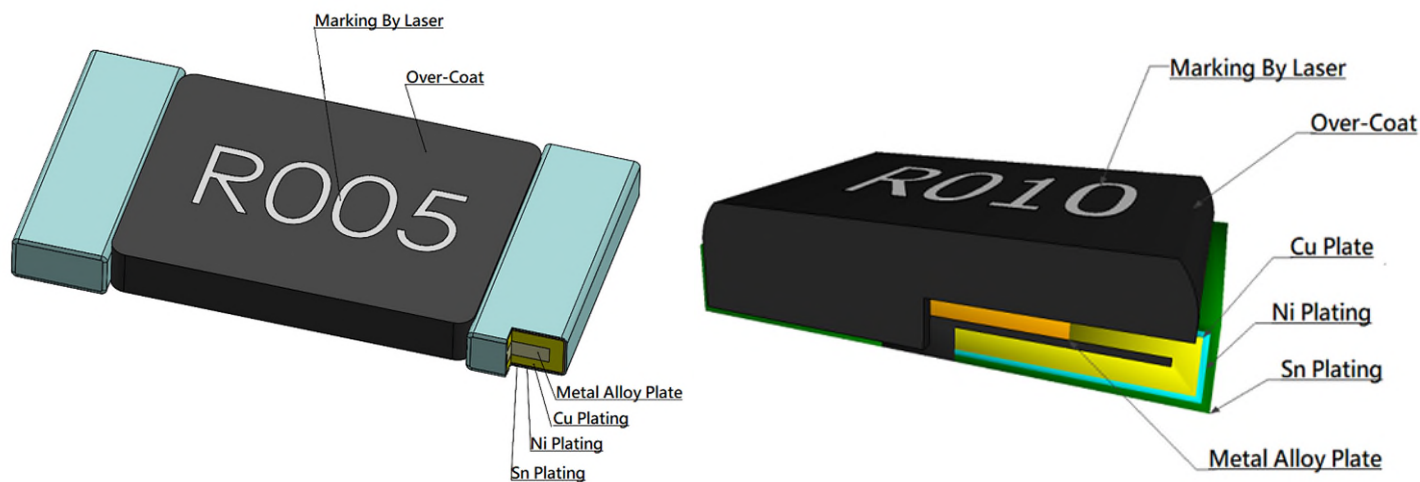

■ Application

- Entertainment equipment
- Power Supply
- Measuring instrument
- Industrial equipment
- Battery management system

■ Features

- Low Resistance / Low TCR/ Low Inductance(Only *Z)
- Excellent long term stability
- RoHs compliant and halogen free
- Lead free
- High precision current sensing and voltage division
- AEC-Q200 Compliant

■ Parts Number Explanation

■ Example:

MR	2512	20	F	R004	M	Z
Product Type	Size (Inch)	Rated Power	Tolerance	Resistance	Material	Optional
	2512 2818	10= 1.00W 20= 2.00W 30= 3.00W 50= 5.00W	D : ±0.5% F : ±1% G : ±2% J : ±5%	R005= 5.0mR R010= 10mR	M : MnCu F : FeCrAl R : NiCrAl S : MnCuSn	Z: Normal Type(Low inductance) G: Anti-Surge Type



MR Series Metal Alloy Low-Resistance Resistor Product Specifications

Document No. S-10-12-09-15

Revised Date 2023/05/26

Page No. 2/8

Standard Electrical Specifications

Type	Rating Power at 70°C	T.C.R. (ppm/°C)	Max. Rating Current	Max. Overload Current	Resistance Range (mΩ)			Material	Operating Temperature Range (°C)
					0.5%(D)	1.0% (F) 2.0% (G) 5.0% (J)			
MR2512*Z <small>note1</small>	1W	≤ ±50	22.36A	50A	6/10/20	2~20	R002~R020 : MnCu	- 55 ~ + 170	
	2W		31.62A	70.71A	6/10/20	2~20	R002~R020 : MnCu		
	3W		38.73A	86.60A	6/10	2~10	R002~R010 : MnCu		
MR2512*G	2W	≤ ±100	44.72A	100.00A	-	1	R001~R004 : MnCu		
		≤ ±50	31.62A	70.71A	-	2~50	R005~R050 : FeCrAl		
	3W	≤ ±100	54.77A	122.47A	-	1	R001~R003 : MnCu		
		≤ ±50	38.73A	86.60A	-	2~50	R004~R050 : FeCrAl		
MR2818*Z <small>note1</small>	5W	≤ ±250	70.71A	141.42A	-	1	R001~R002 : MnCuSn		- 65 ~ + 170
		≤ ±200	50.00A	100.00A	-	2~7	R003~R007 : MnCu		
		≤ ±75	25.00A	50.00A	-	8~50	R008~R050 : NiCrAl		

Notes:

- Inductance characteristics MR 2512*Z, MR 2818*Z ≤ 5nH

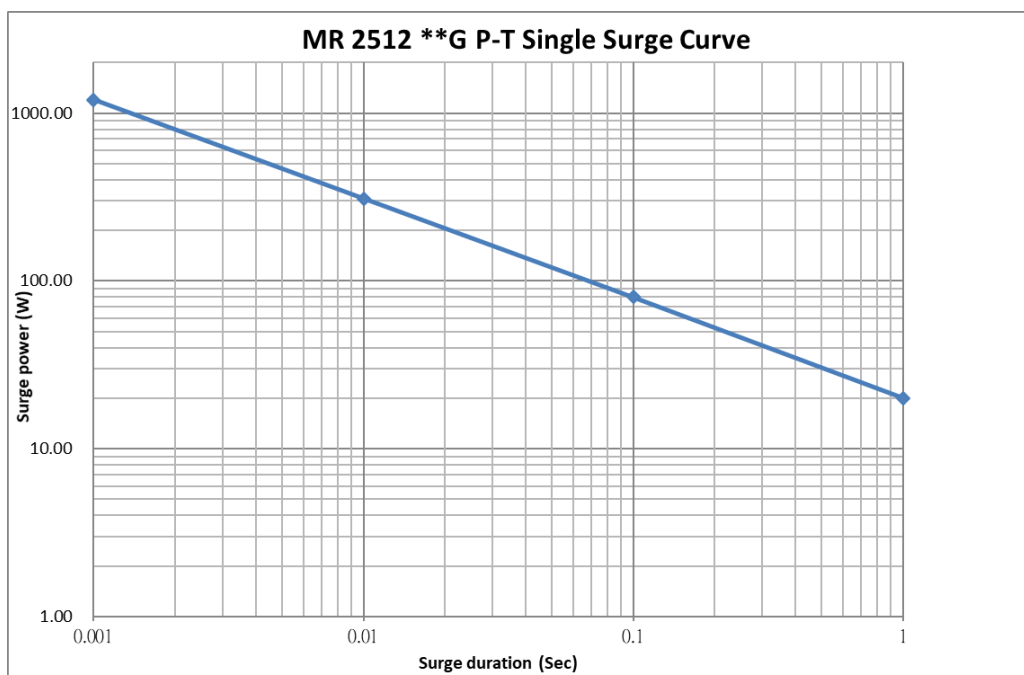



MR Series Metal Alloy Low-Resistance Resistor Product Specifications

Document No. S-10-12-09-15

Revised Date 2023/05/26

Page No. 3/8

■ Type Dimension

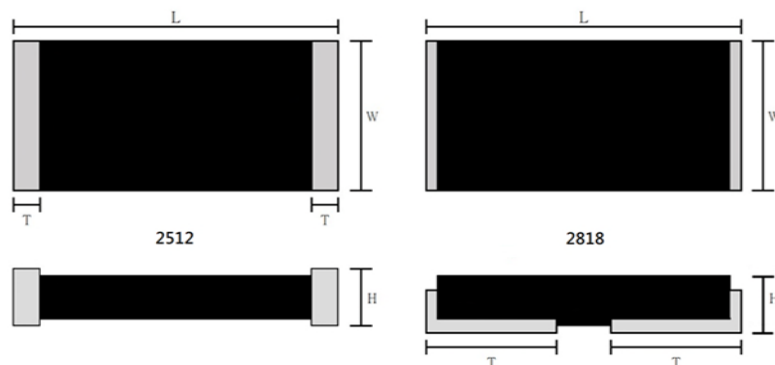

■ Dimension

Unit : mm

Type	Power Rating	Resistance Range	L	W	H	T
MR2512*Z	1W / 2W	2~20mΩ	6.35±0.254	3.10±0.254	0.70±0.254	0.95±0.254
	3W	2~10mΩ			0.70±0.254	0.95±0.254
MR2512*G	2W	1mΩ			0.90±0.254	1.9±0.254
	2W	2mΩ~4mΩ			0.90±0.254	0.80±0.254
	2W	5mΩ~50mΩ			0.90±0.254	0.80±0.254
	3W	1mΩ~3mΩ			1.10±0.254	0.80±0.254
	3W	4mΩ	1.10±0.254	0.80±0.254		
	3W	5mΩ~50mΩ	0.90±0.254	0.80±0.254		
MR2818*Z	5W	1~50mΩ	7.15±0.30	4.95±0.254	1.65±0.254	2.90±0.254



MR Series Metal Alloy Low-Resistance Resistor Product Specifications

Document No. S-10-12-09-15

Revised Date 2023/05/26

Page No. 4/8

■ Performance Characteristics

Power Derating Curve

The Operating Temperature Range: $-55^{\circ}\text{C} \sim +170^{\circ}\text{C}$.

For resistors operated in ambient temperatures above 70°C , power rating must be derating in accordance with the curve as below :

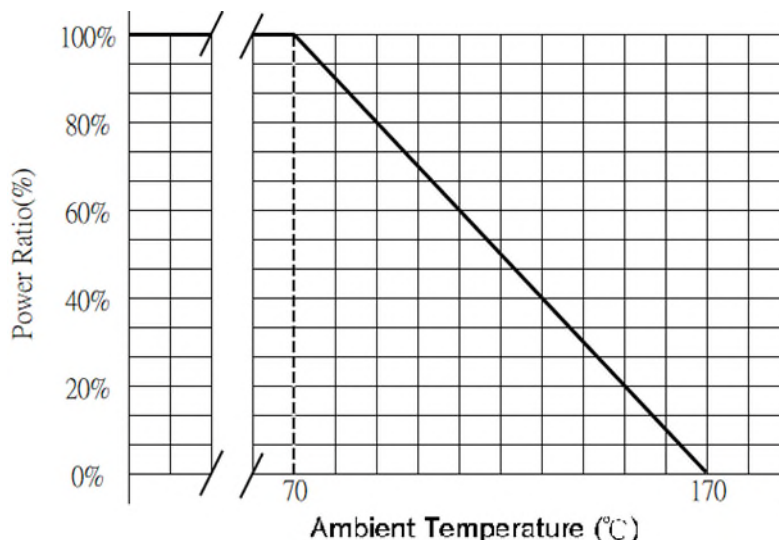

■ Rating Current

The following equation may be used to determine the DC (Direct Current) or AC (Alternating Current) (RMS, root mean square value) of normal rated power. However, if the result value exceeds the highest current of regulated standards, the highest normal rated power is to be used

$$I = \sqrt{P/R}$$

I = Rating current (A)
P= Rating Power (W)
R= Resistance(Ω)

■ Marking Format:

- Marking By Laser
- All the products marking are 4 digits.
- "R" designates the decimal location in ohms
e.g. $3\text{m}\Omega$ the product marking is R003.
 $10\text{m}\Omega$ the product marking is R010.
- The criteria to distinguishing the mark on the surface of products are that characters can be identified.



MR Series Metal Alloy Low-Resistance Resistor Product Specifications

Document No. S-10-12-09-15

Revised Date 2023/05/26

Page No. 5/8

Reliability Test and Requirement

Test Item	Test Method	Procedure	Requirements
Temperature Coefficient of Resistance (T.C.R)	JIS-C-5201-1 4.8 IEC-60115-1 4.8	At 25°C /+125°C, 25°C is the reference temperature	Refer to Ratings
Short Time Overload	JIS-C-5201-1 4.13 IEC-60115-1 4.13	The number of rated power are as follows: <ul style="list-style-type: none"> MR2512-1W: 5 times of rated power MR2512-2W: 5 times of rated power MR2512-3W: 5 times of rated power MR2818-5W: 4 times of rated power for 5 seconds. 	$\Delta R/R1 \leq \pm 1.0\%$
High Temperature Exposure	JIS-C5201-1 4.25 IEC 60068-2-2	At 170°C for 1000 hours.	$\Delta R/R1 \leq \pm 1.0\%$
Resistance to Soldering Heat	JIS-C-5201-1 4.18 IEC-60115-1 4.18	260±5°C for 10 seconds.	$\Delta R/R1 \leq \pm 0.5\%$
Temperature Cycling	JESD22 Method JA-104	1000 Cycles (-55°C to +155°C) Measurement at 24±4 hours after test conclusion. 30min maximum dwell time at each temperature extreme.	$\Delta R/R1 \leq \pm 1.0\%$
Biased Humidity	MIL-STD-202 Method 103	1,000 hours; 85°C / 85% RH, 10% of operating power. Measurement at 24±4 hours after test conclusion.	$\Delta R/R1 \leq \pm 1.0\%$
Load Life (Endurance)	JIS-C-5201-1 4.25 IEC-60115-1 4.25.1	70±2°C, RCWV or Max. working voltage whichever is less for 1000 hrs with 1.5 hrs "ON" and 0.5 hr "OFF" .	$\Delta R/R1 \leq \pm 1.0\%$
Solderability	JIS-C-5201-1 4.17 IEC-60115-1 4.17	245±5°C for 3 seconds.	>95% coverage
Dielectric Withstanding Voltage	JIS-C5201-1 4.7	Applied 500VAC for 1 minute.	No short or burned on the appearance.
Core Body Strength	JIS-C5201-1 4.15	Central part pressurizing force : 5N , 10 seconds	No broken
Terminal Strength (SMD)	AEC Q200-006	Pressurizing force : 17.7N , 60 seconds	No broken
Bending Strength	JIS-C-5201-1 4.33 IEC-60115-1 4.33	Bending once for 2mm , 10 seconds	$\Delta R/R1 \leq \pm 0.5\%$ No broken
Moisture Resistance	MIL-STD 202 Method 106	T=24 hours / Cycle ,10Cycles . Steps 7a& 7b not required. Unpowered . (Figure 1)	$\Delta R/R1 \leq \pm 0.5\%$



MR Series Metal Alloy Low-Resistance Resistor Product Specifications

Document No. S-10-12-09-15

Revised Date 2023/05/26

Page No. 6/8

Figure 1

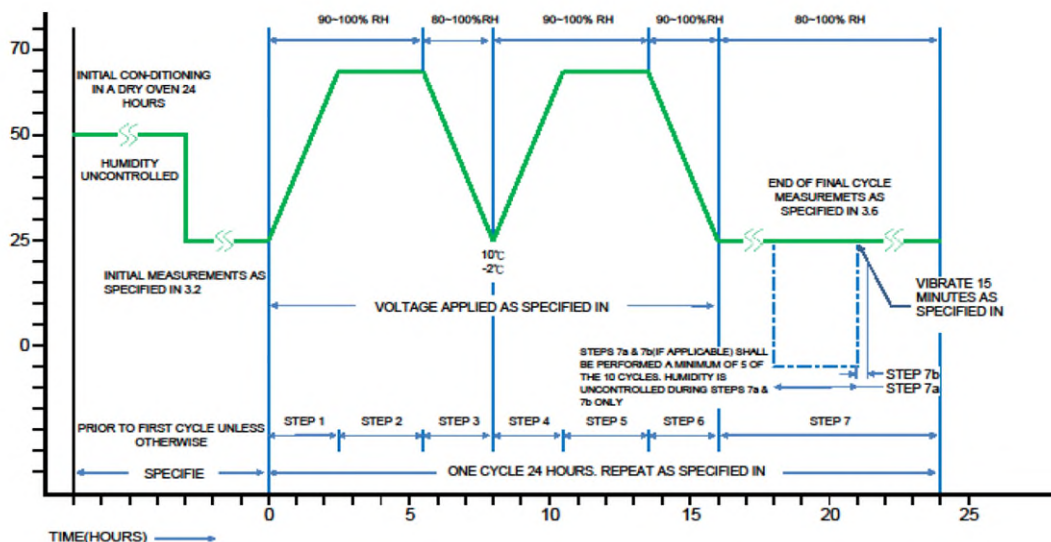

■ Soldering Profile

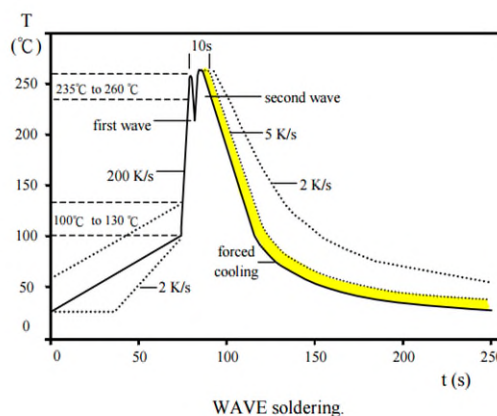
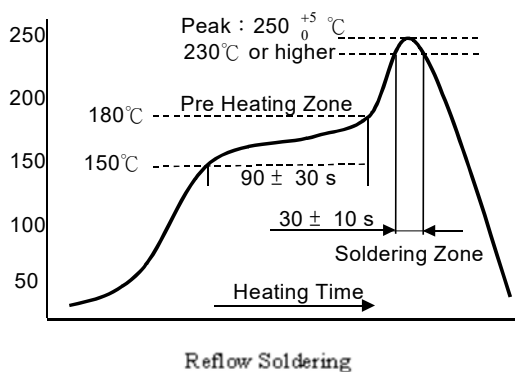



MR Series Metal Alloy Low-Resistance Resistor Product Specifications

Document No. S-10-12-09-15

Revised Date 2023/05/26

Page No. 7/8

Recommend Land Pattern Design

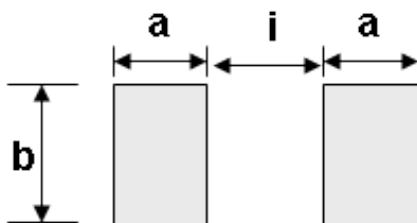

Dimension

Unit: mm

Type	Resistance Range	a	b	i
MR2512*Z – 1W / 2W	2mΩ~20mΩ	2.50	4.50	3.80
MR2512*Z – 3W	2mΩ~10mΩ			
MR2512*G – 2W	1mΩ	3.00	4.50	1.45
MR2512*G – 2W	2mΩ~50mΩ	2.50	4.50	3.80
MR2512*G – 3W	1mΩ~50mΩ	2.50	4.50	3.80
MR2818*Z – 5W	1mΩ~50mΩ	3.50	5.30	0.60

Packing Quantity

Type	PCS /Reel
MR2512*Z-1W/2W/3W	4,000
MR2512*G-2W,1m~50mR	4,000
MR2512*G-3W,1m~4mR	3,000
MR2512*G-3W,5m~50mR	4,000
MR2818-5W	3,500

Appendix For SMD Chip Resistor

● Packaging Information

■ Reel Dimensions

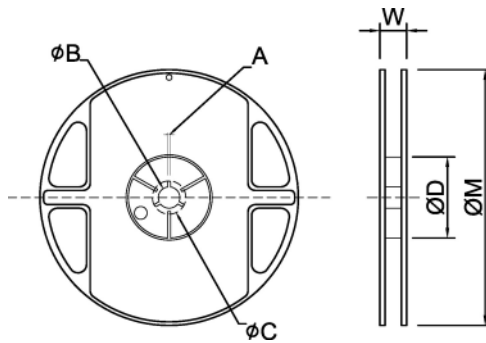

■ Dimension

Unit: mm

Reel Type / Tape	A	φB	φC	φD	W	φM
7" reel for 12 mm embossed	2.5±0.5	13.5±0.5	17.7±0.5	60.0±0.5	16.2±0.5	178±1.0
13" reel for 16 mm embossed	2.3±0.5	13.5±0.5	17.7±0.5	99.0±0.5	20.7±0.5	330±1.0

■ Embossed Dimensions

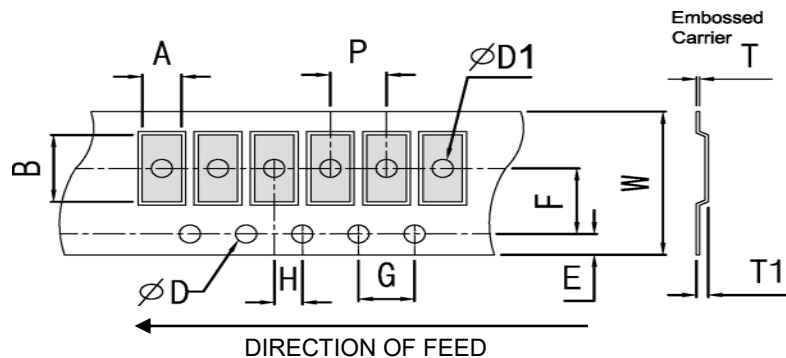

■ Dimension

Unit: mm

Item	W	P	E	F	φD	φD1	G	H	A	B	T1	T
MR2512	12.0±0.30	4.0±0.10	1.75±0.10	5.5±0.10	1.50 ^{+0.1} ₀	1.55±0.10	4.0±0.10	2.0±0.10	3.50±0.10	6.75±0.10	0.90±0.20	0.20±0.10
MR2512*G 3W,1m~4mR	12.0±0.30	4.0±0.10	1.75±0.10	5.5±0.10		1.55±0.10	4.0±0.10	2.0±0.10	3.50±0.10	6.75±0.10	1.30±0.20	0.20±0.10
MR2818	16.0±0.30	8.0±0.10	1.75±0.10	7.5±0.10		1.50 ^{+0.1} ₀	4.0±0.10	2.0±0.10	5.21±0.10	7.69±0.10	1.97±0.10	0.30±0.05

■ Storage Temperature

Temperature : 25±5°C, Humidity : 60±20%