

Anti-Sulfur SMD Chip Resistor—ST Series

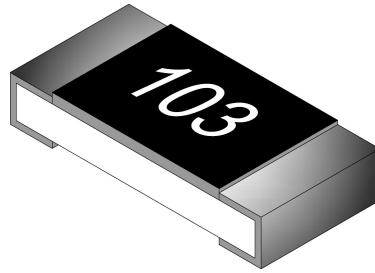

■ Construction

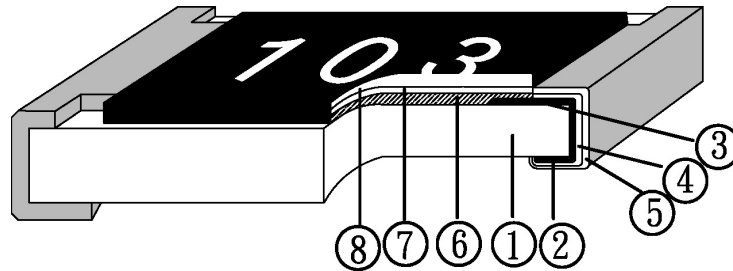

1	Alumina Substrate	5	External Electrode (Sn)
2	Bottom Electrode (Ag)	6	Resistor Layer (RuO ₂)
3	Top Electrode (Ag/Pd)	7	Primary Overcoat (Glass)
4	Barrier Layer (Ni)	8	Secondary Overcoat (Epoxy)

■ Application

- Entertainment: Stereo, TV tuners, Tape recorder
- Appliance: Air conditioner, Refrigerator
- Computer & relative products: Main board, PDA
- Communication equipment: Cell phone, Fax machine
- Power equipment: Power supply, Illumination equipment
- Measuring instrument: Electric meter, Navigation equipment

■ Features

- Small size and light weight
- Reduction of assembly costs and matching with placement machines
- Reliability, high quality and fast delivery

■ Type Dimension

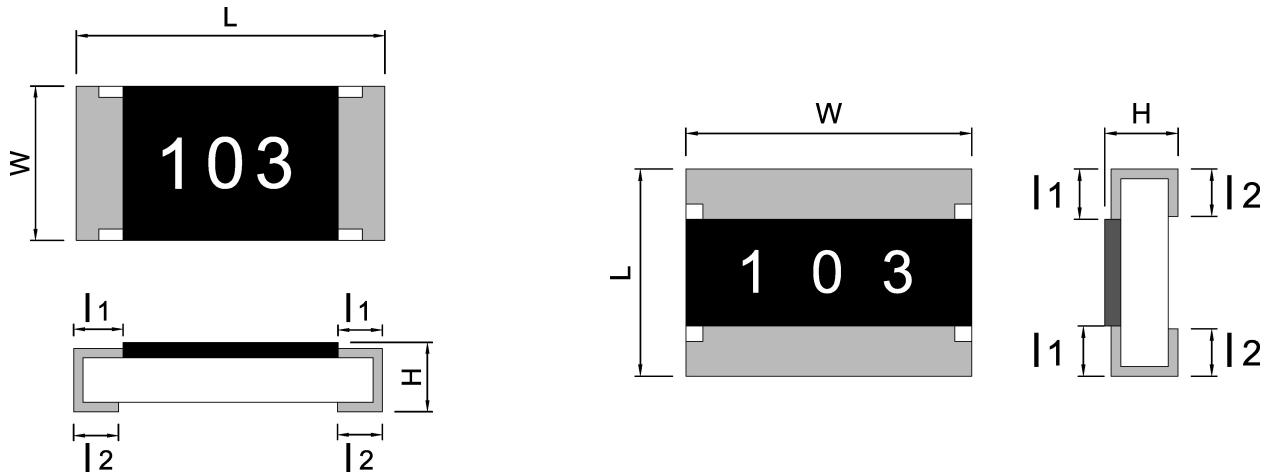

ST0402 / ST0603 / ST0805 / ST1206
ST1210 / ST1812 / ST2010 / ST2512

ST1218 / ST2030

■ Dimension

Unit: mm

TYPE	L	W	H	l ₁	l ₂
ST0402	1.00 ± 0.10	0.50 ± 0.05	0.30 ± 0.05	0.15 ± 0.10	0.20 ± 0.10
ST0603	1.60 ± 0.20	0.80 ± 0.15	0.40 ± 0.10	0.20 ± 0.10	0.30 ± 0.10
ST0805	2.00 ± 0.20	1.25 ± 0.15	0.50 ± 0.15	0.30 ± 0.15	0.40 ± 0.15
ST1206	3.05 ± 0.10	1.60 ± 0.20	0.55 ± 0.15	0.40 ± 0.20	0.50 ± 0.20
ST1210	3.05 ± 0.10	2.50 ± 0.20	0.55 ± 0.15	0.50 ± 0.20	0.50 ± 0.20
ST1812	4.50 ± 0.10	3.00 ± 0.10	0.55 ± 0.05	0.55 ± 0.20	0.70 ± 0.20
ST2010	5.00 ± 0.20	2.50 ± 0.20	0.55 ± 0.10	0.60 ± 0.20	0.60 ± 0.20
ST1218	3.10 ± 0.10	4.60 ± 0.10	0.55 ± 0.05	0.40 ± 0.20	0.50 ± 0.20
ST2512	6.30 ± 0.20	3.20 ± 0.20	0.55 ± 0.10	0.60 ± 0.20	0.60 ± 0.20
ST2030	5.10 ± 0.10	7.60 ± 0.10	0.60 ± 0.05	0.80 ± 0.20	0.80 ± 0.20

Standard & High Power Electrical Specifications

Item Type	Rated Power at 70°C		Max Working Voltage	Max Overload Voltage	T.C.R. (PPM/°C)	Resistance Range			Operating Temperature Range
	Standard	High				B(±0.1%) D(±0.5%)	F(±1%) G(±2%)	J(±5%) K(±10%)	
ST0402	0.063 W	-	50V	100V	0~+400	-	1Ω~9.9Ω	1Ω~9.9Ω	-55°C ~ +155°C
					±300	-	10Ω~990Ω	10Ω~990Ω	
					±200	10Ω~1MΩ	1KΩ~10MΩ	1KΩ~10MΩ	
ST0603	0.1 W	0.125 W	50V	100V	±400	-	1Ω~9.9Ω	1Ω~9.9Ω	
					±200	-	-	10Ω~10MΩ	
					±100	10Ω~1MΩ	10Ω~10MΩ	-	
ST0805	0.125 W	0.25 W	150V	300V	±400	-	1Ω~9.9Ω	1Ω~9.9Ω	
					±200	-	-	10Ω~10MΩ	
					±100	10Ω~1MΩ	10Ω~10MΩ	-	
ST1206	0.25 W	0.5 W	200V	400V	±400	-	1Ω~9.9Ω	1Ω~9.9Ω	
					±200	-	-	10Ω~10MΩ	
					±100	10Ω~1MΩ	10Ω~10MΩ	-	
ST1210	0.33 W	0.66 W	200V	400V	±400	-	1Ω~9.9Ω	1Ω~9.9Ω	
					±200	-	-	10Ω~10MΩ	
					±100	10Ω~1MΩ	10Ω~10MΩ	-	
ST1812	0.5 W	1 W	200V	400V	±400	-	1Ω~9.9Ω	1Ω~9.9Ω	
					±200	-	-	10Ω~10MΩ	
					±100	10Ω~1MΩ	10Ω~10MΩ	-	
ST2010	0.5 W	1 W	200V	400V	±400	-	1Ω~9.9Ω	1Ω~9.9Ω	
					±200	-	-	10Ω~10MΩ	
					±100	10Ω~1MΩ	10Ω~10MΩ	-	
ST1218	1 W	2 W	200V	400V	±400	-	1Ω~9.9Ω	1Ω~9.9Ω	
					±200	-	-	10Ω~10MΩ	
					±100	10Ω~1MΩ	10Ω~10MΩ	-	
ST2512	1 W	2 W	200V	400V	±400	-	1Ω~9.9Ω	1Ω~9.9Ω	
					±200	-	-	10Ω~10MΩ	
					±100	10Ω~1MΩ	10Ω~10MΩ	-	
ST2030	2 W	3 W	200V	400V	±400	-	1Ω~9.9Ω	1Ω~9.9Ω	
					±200	-	-	10Ω~10MΩ	
					±100	10Ω~1MΩ	10Ω~10MΩ	-	

Type	0201	0402	0603	0805	1206	1210	1812	2010	1218	2512	2030
Jumper Rated Current	0.5A	1A			2A						

■ Recommend Land Pattern Design (For Reflow Soldering)

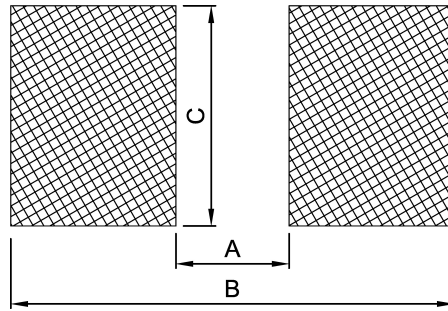

■ Dimension

Unit: mm

Item \ Type	ST0402	ST0603	ST0805	ST1206	ST1210	ST1812	ST2010	ST1218	ST2512	ST2030
A	0.60	0.80	1.30	2.20	2.00	3.11	3.80	2.04	4.90	3.50
B	1.60	2.40	2.90	4.20	4.40	5.91	6.60	4.24	8.10	7.50
C	0.70	1.00	1.40	1.70	2.70	3.00	2.70	4.50	3.40	7.80

■ Packaging

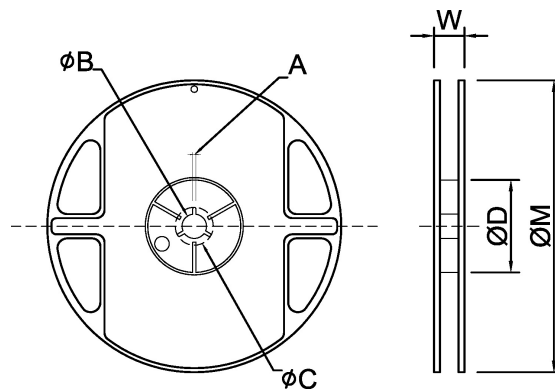

■ Dimension

Unit: mm

TYPE	SIZE		A	ϕB	ϕC	ϕD	W	ϕM
ST0402	7"	10K/Reel	2.0±0.5	13.5±1.0	21±1.0	60±1.0	11.5±2.0	178±2.0
ST0603 ST0805 ST1206	7"	5K/Reel	2.0±0.5	13.5±1.0	21±1.0	60±1.0	11.5±2.0	178±2.0
	10"	10K/Reel	2.0±0.5	13.5±1.0	21±1.0	100±1.0	11.5±2.0	254±2.0
	13"	20K/Reel	2.0±0.5	13.5±1.0	21±1.0	100±1.0	11.5±2.0	330±2.0
ST1210	7"	5K/Reel	2.0±0.5	13.5±1.0	21±1.0	60±1.0	11.5±2.0	178±2.0
ST2010 ST2512 ST1812 ST1218	7"	4K/Reel	2.0±0.5	13.5±1.0	21±1.0	60±1.0	16.0±2.0	178±2.0
ST2030	7"	1K/Reel	2.0±0.5	13.5±1.0	21±1.0	60±1.0	19.0±2.0	178±2.0

■ Tapping Specification

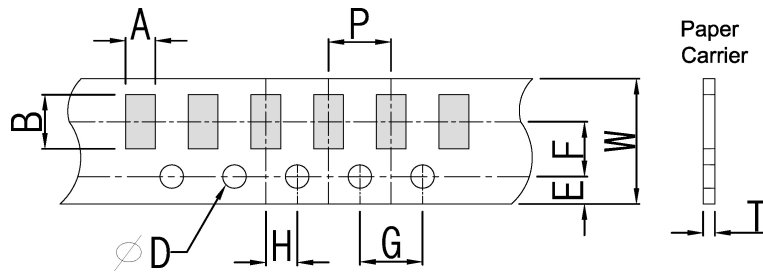

■ Dimension

Unit: mm

Packaging	Type	A	B	W	E	F	G	H	T	∅D	P
Paper Type	ST0402	0.70±0.10	1.20±0.10	8.0±0.20	1.75±0.10	3.5±0.05	4.0±0.10	2.0±0.05	0.45±0.10	1.50±0.10	2.0±0.1
	ST0603	1.05±0.20	1.80±0.20	8.0±0.20	1.75±0.10	3.5±0.05	4.0±0.10	2.0±0.05	0.60±0.10	1.50±0.10	4.0±0.1
	ST0805	1.55±0.20	2.30±0.20	8.0±0.20	1.75±0.10	3.5±0.05	4.0±0.10	2.0±0.05	0.75±0.10	1.50±0.10	
	ST1206	1.90±0.20	3.50±0.20	8.0±0.20	1.75±0.10	3.5±0.05	4.0±0.10	2.0±0.05	0.75±0.10	1.50±0.10	
	ST1210	2.85±0.20	3.50±0.20	8.0±0.20	1.75±0.10	3.5±0.05	4.0±0.10	2.0±0.05	0.75±0.10	1.50±0.10	

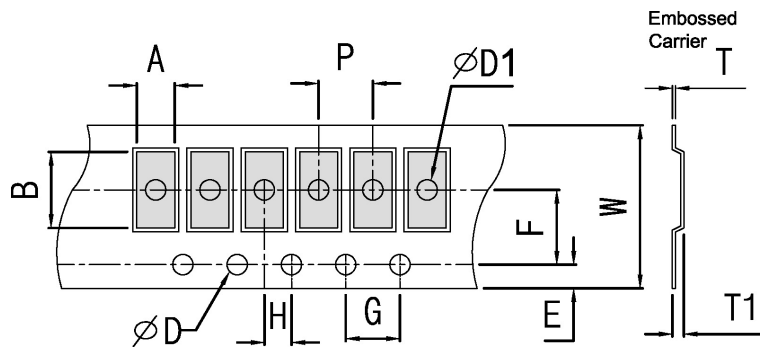

■ Dimension

Unit: mm

Packaging	Type	A	B	W	E	F	G	H	T	∅D	∅D1	T1	P
Embossed Type	ST2010	2.80±0.20	5.60±0.20	12±0.10	1.75±0.10	5.5±0.05	4.0±0.10	2.0±0.05	0.23±0.10	1.50±0.10	1.50±0.10	0.85±0.15	4.0±0.1
	ST2512	3.40±0.20	6.70±0.20	12±0.10	1.75±0.10	5.5±0.05	4.0±0.10	2.0±0.05	0.23±0.10	1.50±0.10	1.50±0.10	0.85±0.15	
	ST1812	3.30±0.20	4.60±0.20	12±0.10	1.75±0.10	5.5±0.05	4.0±0.10	2.0±0.05	0.23±0.10	1.50±0.10	1.50±0.10	0.85±0.15	
	ST1218	3.30±0.20	4.60±0.20	12±0.10	1.75±0.10	5.5±0.05	4.0±0.10	2.0±0.05	0.23±0.10	1.50±0.10	1.50±0.10	0.85±0.15	
	ST2030	5.50±0.20	7.90±0.20	16±0.10	1.75±0.10	7.5±0.05	4.0±0.10	2.0±0.05	0.25±0.10	1.50±0.10	1.50±0.10	0.85±0.15	8.0±0.2

■ Packing Material Data/Storage Data

■ Front & Back Lead Dimension

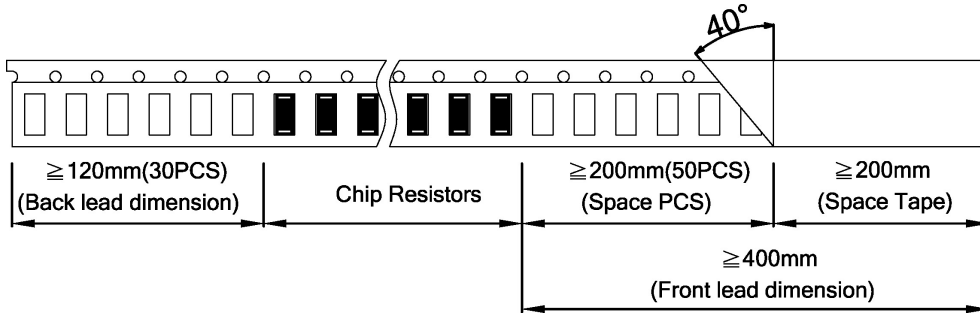

■ Top Adhesive Peel Off Strength : 10~70g

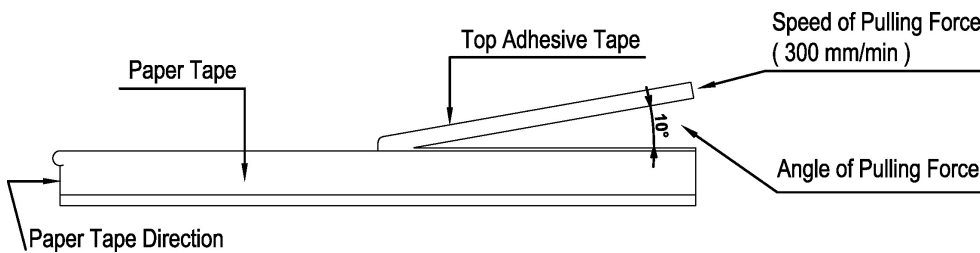

■ Package

Inner Box Size	
Reel	Size H(mm)
1	13
2	24
3	36
5	60
10	113

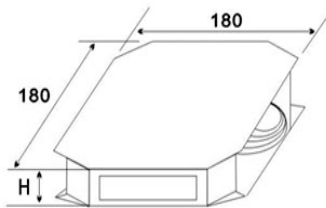

External Box Size			
Contain (Kpcs)	Length (mm)	Width (mm)	Height (mm)
25K	180	180	60
50K	180	180	110
150K	430	200	200
300K	400	400	200

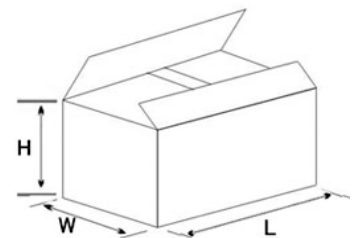

■ Storage Data :

Storage time at the environment temp: 25±5°C & humidity: 50±20% is valid for one year from the date of delivery.

Parts Number Explanation

Example:

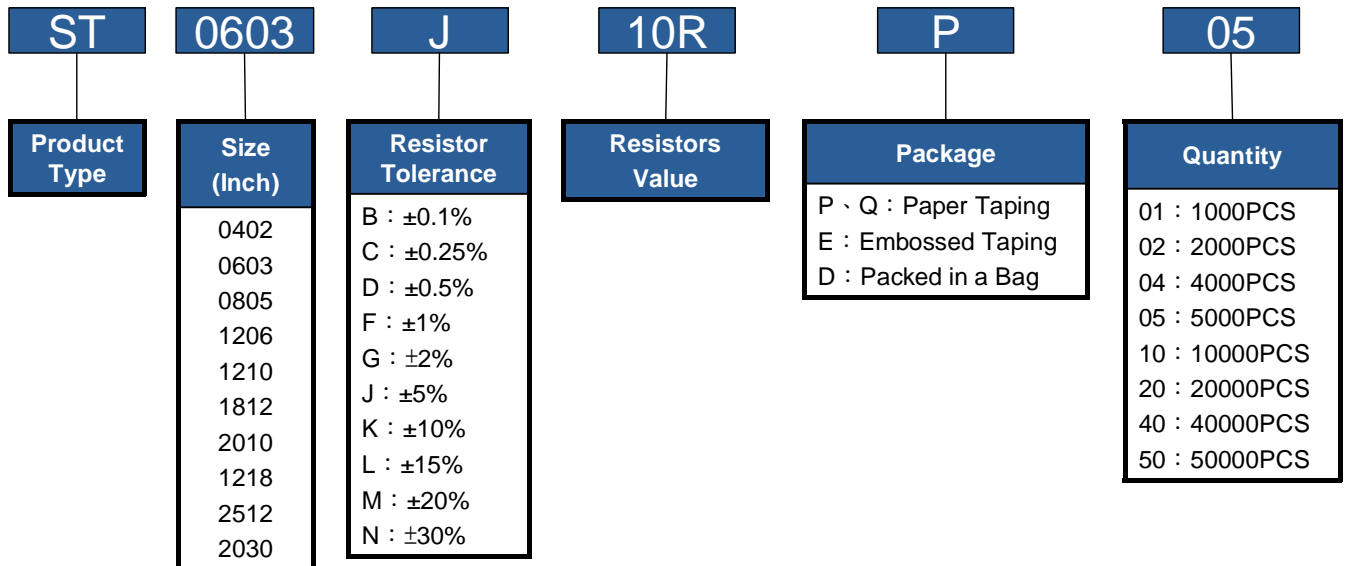

Test Procedures and Requirements

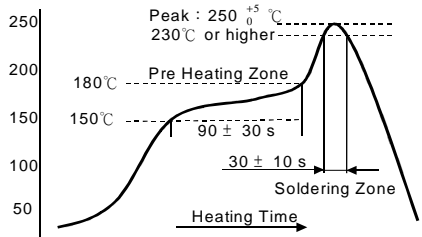
Test Item	Test Method	Procedure	Requirements
Temperature Coefficient of Resistance (T.C.R)	JIS C 5201-1 clause 4.8	-55°C ~ +155°C, 20°C is the reference temperature	Refer to Ratings
Short Time Overload	JIS C 5201-1 clause 4.13	General : 2.5 times RCWV or Max. Overload voltage for 5 seconds. High Power : 2.5 times RCWV or Max. Overload voltage for 2 seconds.	±1 : ±(1.0%+0.05 Ω) ±5 : ±(2.0%+0.1 Ω)
IR Reflow	Sony SS-00254	 <p>The graph shows a temperature profile for IR reflow. The y-axis is temperature in °C (50 to 250) and the x-axis is Heating Time. Key points include: Pre Heating Zone (150°C to 180°C), a dwell at 180°C for 90 ± 30 s, a peak at 250 ± 5 °C (230°C or higher), and a Soldering Zone (30 ± 10 s) during the cooling phase.</p>	±1 : ±(1.0%+0.05 Ω) ±5 : ±(1.0%+0.05 Ω)
Leaching	Sony SS-00254-9	260±5°C for 30 seconds.	>95% Coverage
Soldering Heat	JIS C 5201-1 clause 4.18	260±5°C for 10 seconds.	±1 : ±(0.5%+0.05 Ω) ±5 : ±(1.0%+0.05 Ω)
Temperature Cycling	JIS C 5201-1 clause 4.19	-55°C to +155°C, 5 cycles	0.1%、0.5%、1% : ±(0.5%+0.05 Ω) 2%、5% : ±(1.0%+0.10 Ω)
Electric Iron	Sony SS-00254-5	Preheating temperature : 350±10°C Electric iron preheating time : 3+1/-0 sec	±1 : ±(1.0%+0.05 Ω) ±5 : ±(1.0%+0.05 Ω)
Resistance to Solvent	JIS C 5201-1 clause 4.29	The tested resistor be immersed into isopropyl alcohol of 20~25°C for 60 secs. Then the resistor is left in the room for 48 hrs.	±1 : ±(0.5%+0.05 Ω) ±5 : ±(0.5%+0.05 Ω)
Load Life in Humidity	JIS C 5201-1 clause 4.24	40±2°C, 90~95% R.H. or Max. working voltage for 1000 hrs with 1.5 hrs "ON" and 0.5 hr "OFF" .	0.1%、0.5%、1% : ±(0.5%+0.05 Ω) 2%、5% : ±(2.0%+0.05 Ω)
Load Life (Endurance)	JIS C 5201-1 clause 4.25	70±2°C, or Max. working voltage for 1000 hrs with 1.5 hrs "ON" and 0.5 hr "OFF" .	0.1%、0.5%、1% : ±(1.0%+0.05 Ω) 2%、5% : ±(3.0%+0.10 Ω)
Terminal Bending Strength	JIS C 5201-1 clause 4.33	Bending once for 5 seconds D : ST Series 0402、0603、0805=5mm ST Series 1206、1210、1812=3mm ST Series 1218、2010、2512=2mm	±1 : ±(1.0%+0.05 Ω) ±5 : ±(1.0%+0.05 Ω)
Insulation Resistance	JIS C 5201-1 clause 4.6	Max. Overload voltage for 1 minute.	≥ 10G Ω
Sulfur Test	ASTM-B-809-95	60±2°C, no power rating for 1000 hrs	△R : ±(1.0%+0.05 Ω)

■ Performance Characteristics

■ Power Derating Curve

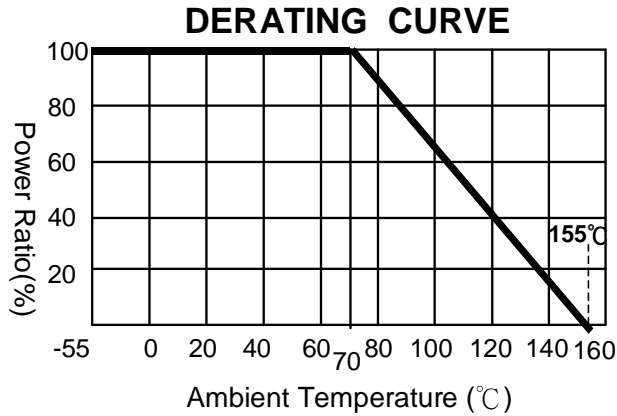

Power rating or current rating is in the case based on continuous full-load at ambient temperature of 70°C. For operation at ambient temperature in excess of 70°C, the load should be derated in accordance with figure of derating Curve.

■ Voltage Rating or Current Rating

Resistance Range: $\geq 1 \Omega$

Rated Voltage: The resistor shall have a DC continuous working voltage or a RMS AC continuous working voltage at commercial-line frequency and wave form corresponding to the power rating, as determined formula as following:

$$E = \sqrt{P \times R}$$

E=Rated voltage(V)
 P=Power rating(W)
 R=Nominal resistance(Ω)

■ Operation and Storage Temperature

	MIN	MAX
Operation temperature	-55°C	70°C
Storage temperature	20°C	30°C
Storage humidity	30%	70%

■ Soldering Profile

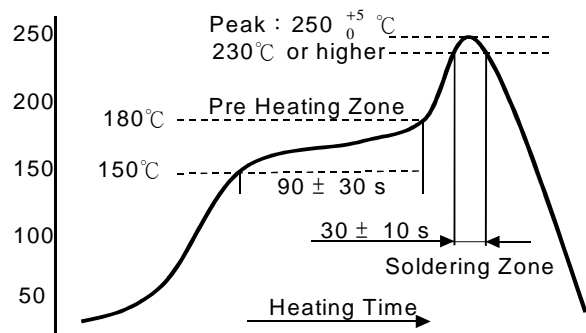

■ Equipments Applicable:

Our company's products are produced under low temperature processing applicable to IR reflow surface mounting devices. It is comparatively not applicable to wave soldering which will possibly cause the risk ablating the element protection layer and the front conductor and cause the drift of the resistance value and ablation of the markings.

■ Product Testing Method:

Our products are tested with our company's tapping & testing equipments by using four-feet probe to touch at the back of both electrodes. Supposed different testing points or methods are requested, please advise beforehand and customized-made production is available.

■ 0603 E-96 Multiplier Code

Code	A	B	C	D	E	F	G	H	X	Y	Z
Multiplier	10 ⁰	10 ¹	10 ²	10 ³	10 ⁴	10 ⁵	10 ⁶	10 ⁷	10 ⁻¹	10 ⁻²	10 ⁻³

CODING FORMULA

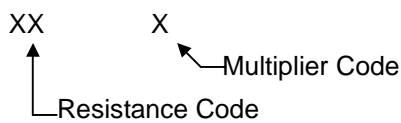

Example: 10.2KΩ = $\frac{102}{10} \times 10^2 \Omega = 02C$
 33.2Ω = $\frac{332}{10} \times 10^{-1} \Omega = 51X$

■ 0603 Standard E-96 Values and 0603 Resistance Codes

R-Value	100	102	105	107	110	113	115	118	121	124	127	130	133	137	140	143	147	150	154	158	162	165	169	174
Code	01	02	03	04	05	06	07	08	09	10	11	12	13	14	15	16	17	18	19	20	21	22	23	24
R-Value	178	182	187	191	196	200	205	210	215	221	226	232	237	243	249	255	261	267	274	280	287	294	301	309
Code	25	26	27	28	29	30	31	32	33	34	35	36	37	38	39	40	41	42	43	44	45	46	47	48
R-Value	316	324	332	340	348	357	365	374	383	392	402	412	422	432	442	453	464	475	487	499	511	523	536	549
Code	49	50	51	52	53	54	55	56	57	58	59	60	61	62	63	64	65	66	67	68	69	70	71	72
R-Value	562	576	590	604	619	634	649	665	681	698	715	732	750	768	787	806	825	845	866	887	909	931	953	976
Code	73	74	75	76	77	78	79	80	81	82	83	84	85	86	87	88	89	90	91	92	93	94	95	96

Standard Resistance Values in a Decade

Marking code:

- TYPE : ST Series
- 1%: marking code, please refer to E96 and E24 data form as below
 Ex: 120K, The marking code is 1203 in E24
 121K, The marking code is 1213 in E96
- 5%: marking code, please refer to E24 data form as below
 Ex: 120K, The marking code is 124 in E24
- Note: 0201 / 0402 series resistor has no marking code.
- Type: 0603 1% marking code, please refer to E-96 multiplier code.

E192	E96	E48	E192	E96	E48	E192	E96	E48	E192	E96	E48	E192	E96	E48	
100	100	100	169	169	169	287	287	287	487	487	487	825	825	825	
101			172			291			493			835			
102	102		174	174		294	294		499	499		845	845		
104			176			298			505			856			
105	105	105	178	178	178	301	301	301	511	511	511	866	866	866	
106			180			305			517			876			
107	107		182	182		309	309		523	523		887	887		
109			184			312			530			898			
110	110	110	187	187	187	316	316	316	536	536	536	909	909	909	
111			189			320			542			920			
113	113		191	191		324	324		549	549		931	931		
114			193			328			556			942			
115	115	115	196	196	196	332	332	332	562	562	562	953	953	953	
117			198			336			569			965			
118	118		200	200		340	340		576	576		976	976		
120			203			344			583			988			
121	121	121	205	205	205	348	348	348	590	590	590				
123			208			352			597						
124	124		210	210		357	357		604	604		E24	E12	E6	E3
126			213			361			612			10	10	10	10
127	127	127	215	215	215	365	365	365	619	619	619	11			
129			218			370			626			12	12		
130	130		221	221		374	374		634	634		13			
132			223			379			642			15	15	15	
133	133	133	226	226	226	383	383	383	649	649	649	16			
135			229			388			657			18	18		
137	137		232	232		392	392		665	665		20			
138			234			397			673			22	22	22	22
140	140	140	237	237	237	402	402	402	681	681	681	24			
142			240			407			690			27	27		
143	143		243	243		412	412		698	698		30			
145			246			417			706			33	33	33	
147	147	147	249	249	249	422	422	422	715	715	715	36			
149			252			427			723			39	39		
150	150		255	255		432	432		732	732		43			
152			258			437			741			47	47	47	47
154	154	154	261	261	261	442	442	442	750	750	750	51			
156			264			448			759			56	56		
158	158		267	267		453	453		768	768		62			
160			271			459			777			68	68	68	
162	162	162	274	274	274	464	464	464	787	787	787	75			
164			277			470			796			82	82		
165	165		280	280		475	475		806	806		91			
167			284			481			816						

According to IEC publication 63